

BUILDING ENTRY SYSTEMS

ACS - 35 WIRING DIAGRAM (4 WIRE COMMON)

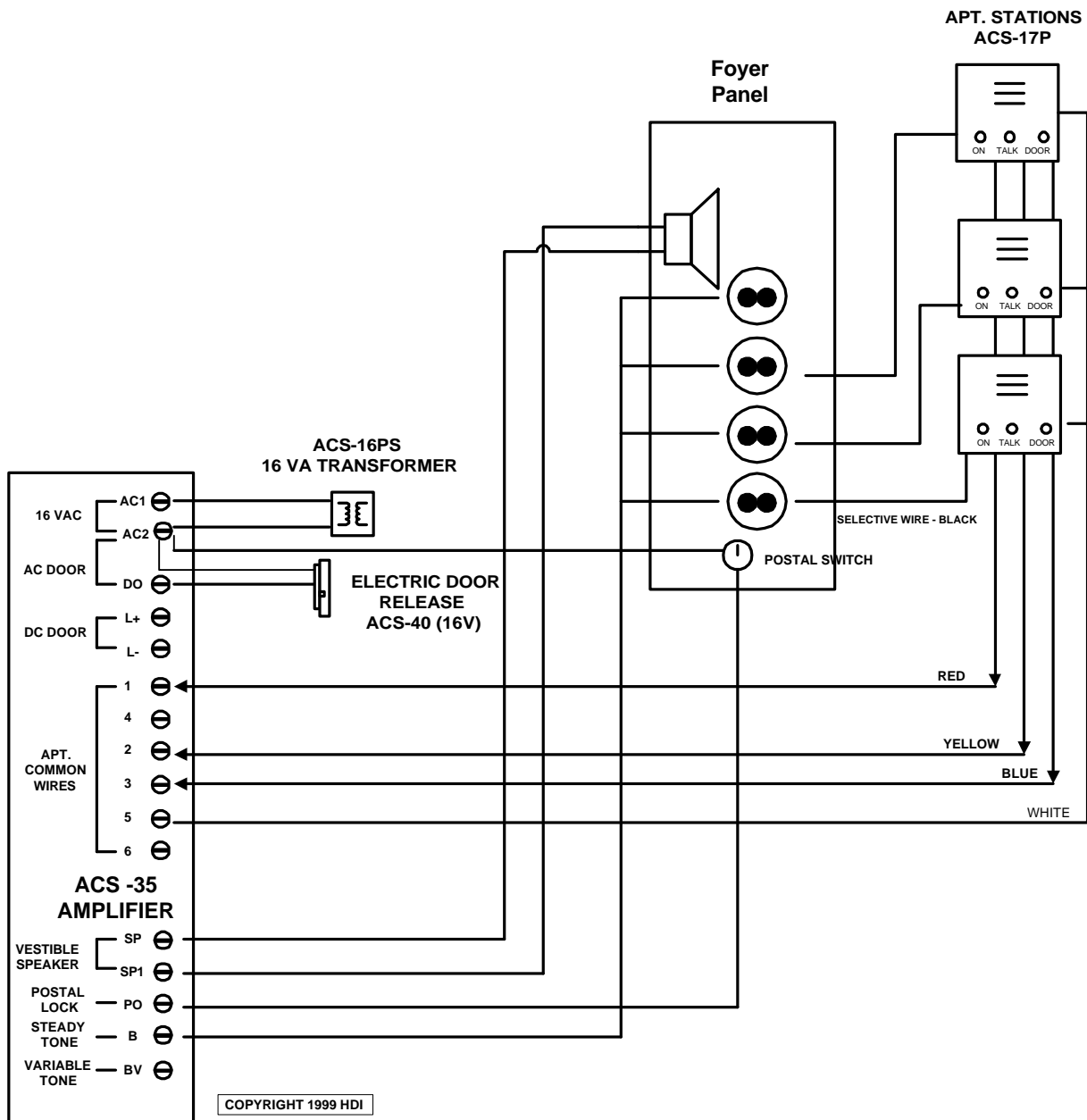

HOUSING DEVICES, INC

407 REAR MYSTIC AVENUE MEDFORD, MA 02155

800-392-5200

781-395-8000 FAX